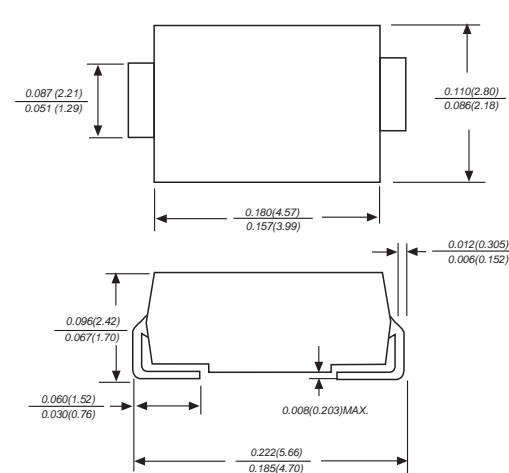

**V. TVS & Overvoltage Protection Device**

**400W Surface Mount TVS (Breakdown Voltage: 6.8~600 Volts)**

**P4SMA Series**

**(Package: SMA (DO-214AC))**

<p><b>FEATURES</b></p> <ul style="list-style-type: none"> <li>• Glass passivated die construction</li> <li>• 400W Peak pulse power dissipation</li> <li>• Uni and Bi-directional versions available</li> <li>• Excellent clamping capability</li> <li>• Fast response time</li> <li>• Plastic material : UL Flammability Classification Rating 94V-0</li> </ul> <p><b>MECHANICAL DATA</b></p> <ul style="list-style-type: none"> <li>• Case : DO-214AC, transfer molded epoxy</li> <li>• Terminals : Solderable per MIL-STD-202, Method 208</li> <li>• Polarity : Color band denotes cathode except for bi-directional types</li> <li>• Mounting Position : Any</li> <li>• Weight : 0.058 grams (approx.)</li> </ul>	 <p style="text-align: center;">Case: SMA Dimensions in inches and (millimetres)</p>
--	--

**Devices for Bi-Directional Applications**

For bi-directional devices use suffix “CA” for types P4SMA6.8CA thru P4SMA600CA (e.g. P4SMA68CA)

Electrical characteristics apply in both directions.

**Maximum Ratings, Thermal & Electrical Characteristics**

**(Ratings at 25 °C ambient temperature unless otherwise specified)**

Ratings	Symbol	Value	Units
Peak power dissipation with a 10/1000µs waveform <sup>(1)</sup>	P <sub>PPM</sub>	400	Watts
Peak pulse current with a 10/1000µs waveform <sup>(1)</sup>	I <sub>PPM</sub>	See next table	Amps
Power dissipation on infinite heatsink at T <sub>L</sub> =75	P <sub>D</sub>	1.0	Watts
Peak forward surge current, 8.3ms single half sine-wave unidirectional only <sup>(2)</sup>	I <sub>FSM</sub>	40	Amps
Maximum instantaneous forward voltage at 25A for unidirectional only <sup>(3)</sup>	V <sub>F</sub>	3.5/5.0	Volts
Operating junction and storage temperature range	T <sub>j</sub> , T <sub>stg</sub>	-55 to +150	

Notes:

1. Non-repetitive current pulse per Fig. 5 and derated above Ta = 25 °C per Fig. 1

2. Measured on 8.3ms single half sine-wave or equivalent square wave, duty cycle = 4 pulses per minute maximum.

3. V<sub>F</sub><3.5V for devices of V<sub>(BR)</sub><200V and V<sub>F</sub><5.0V for devices of V<sub>(BR)</sub>>201V

## V. TVS & Overvoltage Protection Device

### 400W Surface Mount TVS (Breakdown Voltage: 6.8~600 Volts)

#### P4SMA Series

(Package: SMA (DO-214AC))

Device Type	Device Marking Code			Breakdown Voltage $V_{(BR)}$ @ $I_T$			Maximum Reverse Leakage $I_R$ @ $V_{WM}$ ( $\mu A$ ) <sup>(1)</sup>	Working Peak Reverse Voltage $V_{WM}$ (V)	Maximum Reverse Surge Current $I_{PPM}$ (A)	Maximum Clamping Voltage $V_C$ @ $I_{PPM}$ (V)
	Option 1	Option 2		Min (V)	Max (V)	$I_T$ (mA)				
	Full Part Number	Uni	Bi							
P4SMA6.8(C)A	Full PN	6V8A	6V8C	6.46	7.14	10	1000	5.8	38.10	10.5
P4SMA7.5(C)A	Full PN	7V5A	7V5C	7.13	7.88	10	500	6.4	35.40	11.3
P4SMA8.2(C)A	Full PN	8V2A	8V2C	7.79	8.61	10	200	7.0	33.06	12.1
P4SMA9.1(C)A	Full PN	9V1A	9V1C	8.65	9.56	1	50	7.8	29.85	13.4
P4SMA10(C)A	Full PN	10A	10C	9.50	10.50	1	10	8.6	27.59	14.5
P4SMA11(C)A	Full PN	11A	11C	10.45	11.55	1	5	9.4	25.64	15.6
P4SMA12(C)A	Full PN	12A	12C	11.40	12.60	1	5	10.2	23.95	16.7
P4SMA13(C)A	Full PN	13A	13C	12.35	13.65	1	1	11.1	21.98	18.2
P4SMA15(C)A	Full PN	15A	15C	14.25	15.75	1	1	12.8	18.87	21.2
P4SMA16(C)A	Full PN	16A	16C	15.20	16.80	1	1	13.6	17.78	22.5
P4SMA18(C)A	Full PN	18A	18C	17.10	18.90	1	1	15.3	15.87	25.2
P4SMA20(C)A	Full PN	20A	20C	19.00	21.00	1	1	17.1	14.44	27.7
P4SMA22(C)A	Full PN	22A	22C	20.90	23.10	1	1	18.8	13.07	30.6
P4SMA24(C)A	Full PN	24A	24C	22.80	25.20	1	1	20.5	12.05	33.2
P4SMA27(C)A	Full PN	27A	27C	25.65	28.35	1	1	23.1	10.67	37.5
P4SMA30(C)A	Full PN	30A	30C	28.50	31.50	1	1	25.6	9.66	41.4
P4SMA33(C)A	Full PN	33A	33C	31.35	34.65	1	1	28.2	8.75	45.7
P4SMA36(C)A	Full PN	36A	36C	34.20	37.80	1	1	30.8	8.02	49.9
P4SMA39(C)A	Full PN	39A	39C	37.05	40.95	1	1	33.3	7.42	53.9
P4SMA43(C)A	Full PN	43A	43C	40.85	45.15	1	1	36.8	6.75	59.3
P4SMA47(C)A	Full PN	47A	47C	44.65	49.35	1	1	40.2	6.17	64.8
P4SMA51(C)A	Full PN	51A	51C	48.45	53.55	1	1	43.6	5.71	70.1
P4SMA56(C)A	Full PN	56A	56C	53.20	58.80	1	1	47.8	5.19	77.0
P4SMA62(C)A	Full PN	62A	62C	58.90	65.10	1	1	53.0	4.71	85.0
P4SMA68(C)A	Full PN	68A	68C	64.60	71.40	1	1	58.1	4.35	92.0
P4SMA75(C)A	Full PN	75A	75C	71.25	78.75	1	1	64.1	3.88	103.0
P4SMA82(C)A	Full PN	82A	82C	77.90	86.10	1	1	70.1	3.54	113.0
P4SMA91(C)A	Full PN	91A	91C	86.45	95.55	1	1	77.8	3.20	125.0
P4SMA100(C)A	Full PN	100A	100C	95.00	105.00	1	1	85.5	2.92	137.0
P4SMA110(C)A	Full PN	110A	110C	104.50	115.50	1	1	94.0	2.63	152.0
P4SMA120(C)A	Full PN	120A	120C	114.00	126.00	1	1	102.0	2.42	165.0
P4SMA130(C)A	Full PN	130A	130C	123.50	136.50	1	1	111.0	2.23	179.0
P4SMA150(C)A	Full PN	150A	150C	142.50	157.50	1	1	128.0	1.93	207.0
P4SMA160(C)A	Full PN	160A	160C	152.00	168.00	1	1	136.0	1.83	219.0
P4SMA170(C)A	Full PN	170A	170C	161.50	178.50	1	1	145.0	1.71	234.0
P4SMA180(C)A	Full PN	180A	180C	171.00	189.00	1	1	154.0	1.63	246.0
P4SMA200(C)A	Full PN	200A	200C	190.00	210.00	1	1	171.0	1.46	274.0
P4SMA220(C)A	Full PN	220A	220C	209.00	231.00	1	1	185.0	1.22	328.0
P4SMA250(C)A	Full PN	250A	250C	237.50	262.50	1	1	214.0	1.16	344.0
P4SMA300(C)A	Full PN	300A	300C	285.00	315.00	1	1	256.0	0.97	414.0
P4SMA350(C)A	Full PN	350A	350C	332.50	367.50	1	1	299.3	0.83	482.0
P4SMA380(C)A	Full PN	380A	380C	361.00	399.00	1	1	324.9	0.76	524.4
P4SMA400(C)A	Full PN	400A	400C	380.00	420.00	1	1	342.0	0.72	552.0
P4SMA440(C)A	Full PN	440A	440C	418.00	462.00	1	1	376.2	0.66	607.2
P4SMA480(C)A	Full PN	480A	480C	456.00	504.00	1	1	410.4	0.60	662.4
P4SMA520(C)A	Full PN	520A	520C	494.00	546.00	1	1	444.6	0.56	717.6
P4SMA550(C)A	Full PN	550A	550C	522.50	577.50	1	1	470.3	0.53	759.0
P4SMA600(C)A	Full PN	600A	600C	570.00	630.00	1	1	513.0	0.48	828.0

Note:

1. For bi-directional types having  $V_{WM}$  of 10 volts and less, the  $I_R$  limit is doubled.

## Ratings and Characteristic Curves of P4SMA Series

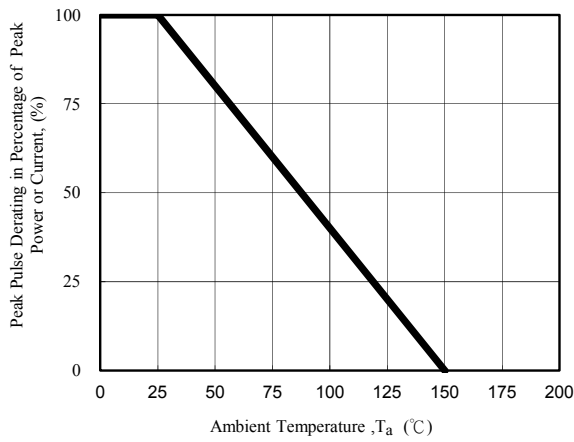

Fig. 1 - Pulse Derating Curve

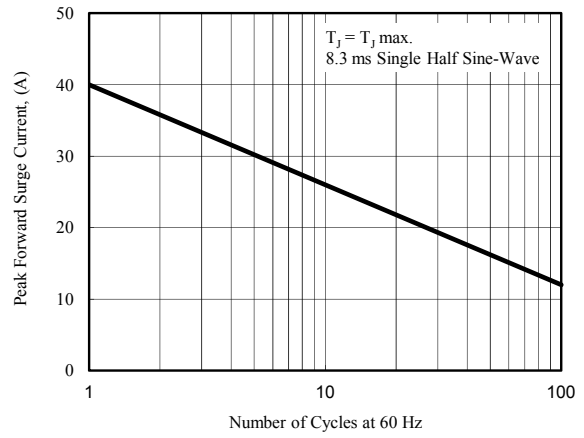

Fig. 2 - Maximum Non-Repetitive Surge Current

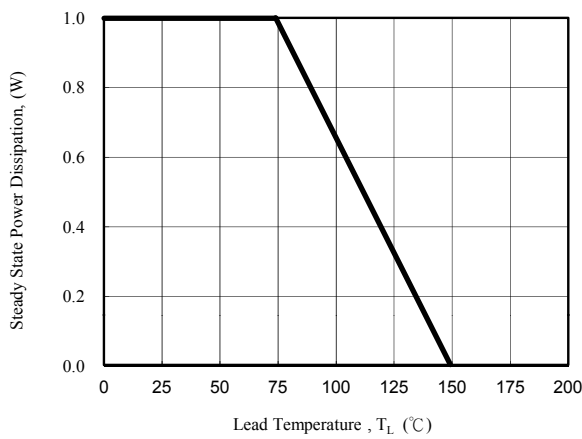

Fig. 3 - Steady State Power Derating Curve

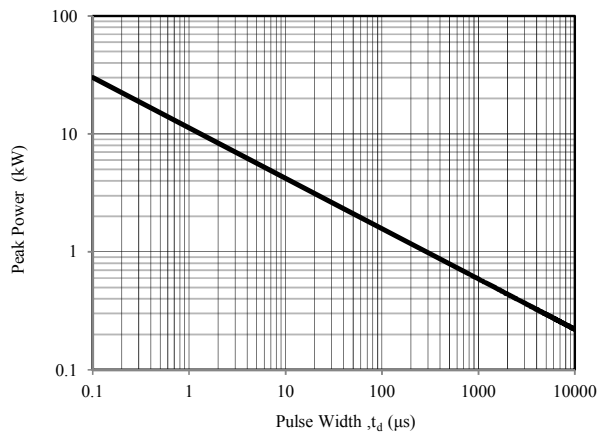

Fig. 4 - Peak Pulse Power Rating Curve

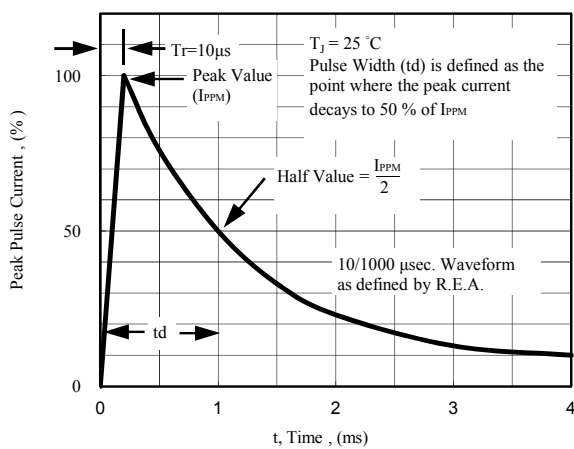

Fig. 5 - Pulse Waveform

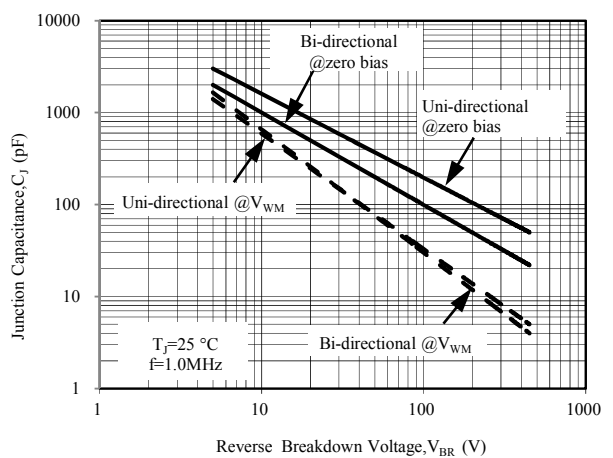

Fig. 6 - Typical Junction Capacitance